

MAPS/DECAL Status

Paul Dauncey
for the CALICE-UK MAPS group

Motivation

- Average number of **charged particles** in an EM shower \propto **incident energy**
 - Fluctuations around the average occur due to statistical nature of the shower
- Average **energy deposited** in the sensitive layers \propto number of **charged particles**
 - Fluctuations around the average occur due to angle of incidence, velocity and Landau spread

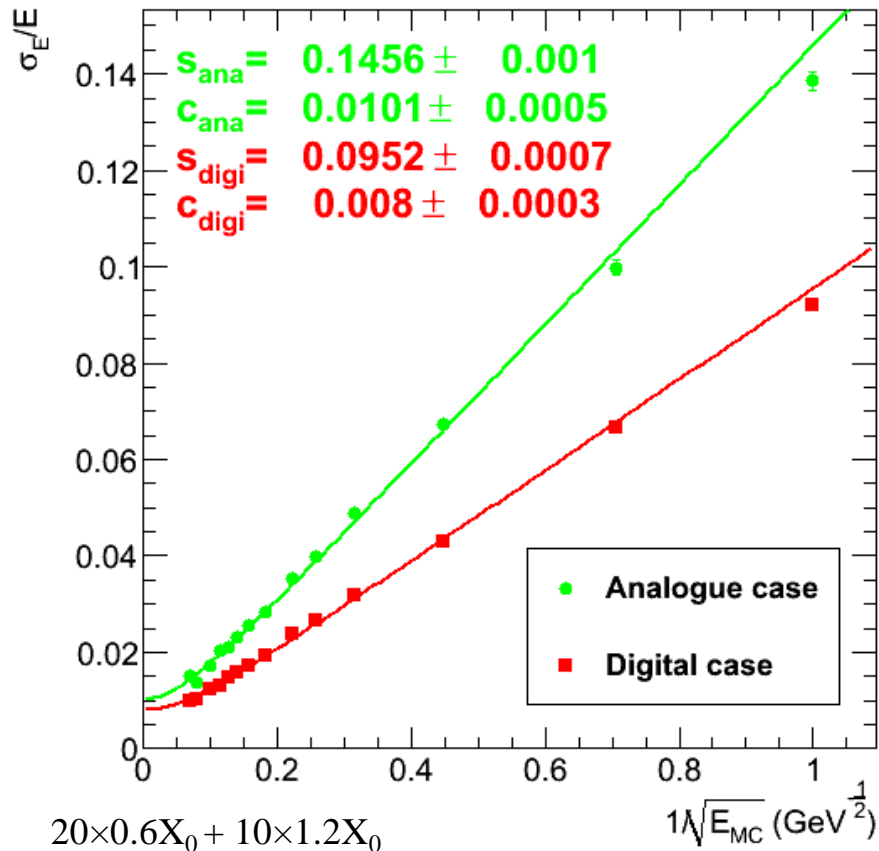

- Number of charged particles is an **intrinsically better measure** than the energy deposited
 - Energy deposited (“analogue” ECAL) resolution $\sim 50\%$ worse than number of particles (“digital” ECAL) resolution
- Can we measure the number of charged particles **directly**?
 - Can we get anywhere near the **ideal resolution**?

Digital ECAL concept

- Make **pixellated detector** with small pixels
 - Probability of more than one charged particle per pixel must be small
 - Allows **binary** readout = hit/no hit
- EM shower density $\sim 100/\text{mm}^2$ in core so need pixels $\sim 50\mu\text{m}$
 - Results in huge number of pixels in a real ECAL $\sim 10^{12}$ pixels

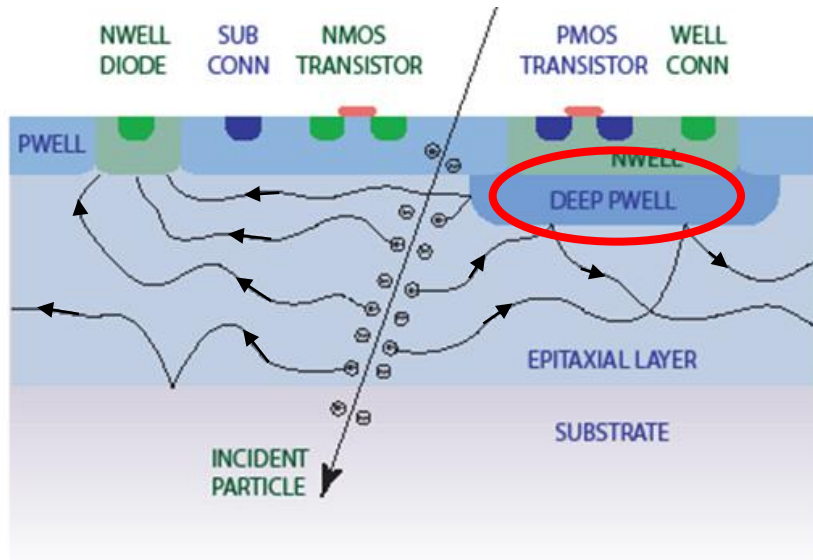
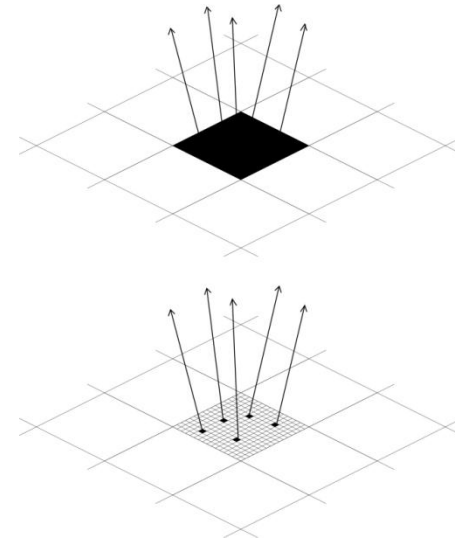

- Cannot afford to have external electronics with individual connections to so many channels
 - Need readout integrated into pixel
 - Implement as **CMOS MAPS sensor**
 - Includes **deep p-well** process to shield PMOS circuit transistors

- Very high granularity should help with PFA too
 - Requires major systematic study; here concentrate on **EM resolution**

TPAC1.0 sensor

- 168×168 pixels = 28k total, each $50 \times 50 \mu\text{m}^2$
- Two major pixel variants, each in two capacitor combinations
 - Only one major variant worked well; “preShaper”
 - Both minor variants (Quad0 and Quad1) worked
 - All results shown are from this type
- Every pixel has 4 diodes, Q-preamp, mask and 4-bit pedestal trim, asynchronous comparator and monostable to give hit/no hit response
- Pixel hits stored with 13-bit timestamp on-sensor until end of bunch train
- Memory for data storage inactive; **11% dead area** in four columns

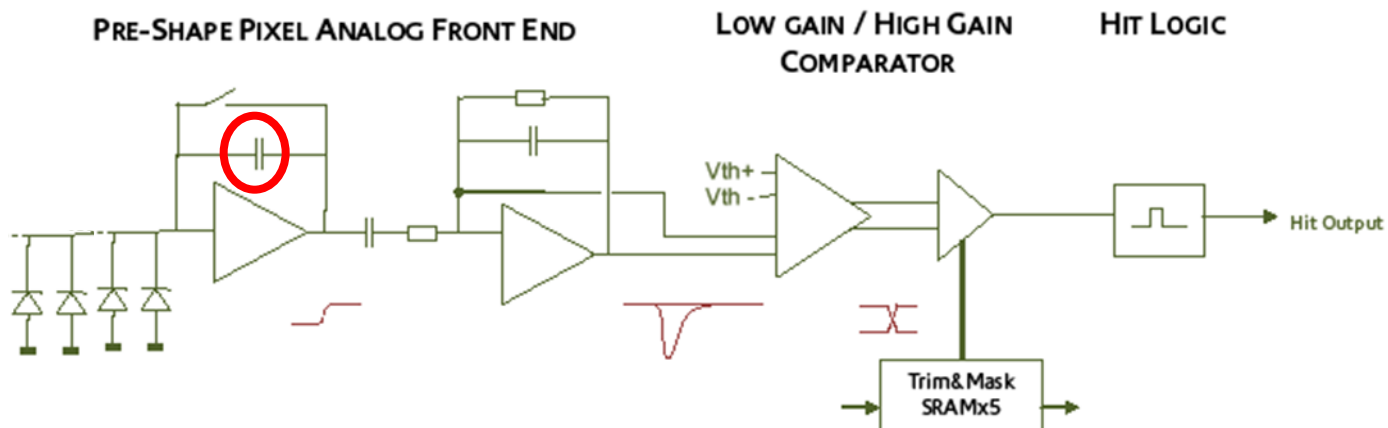
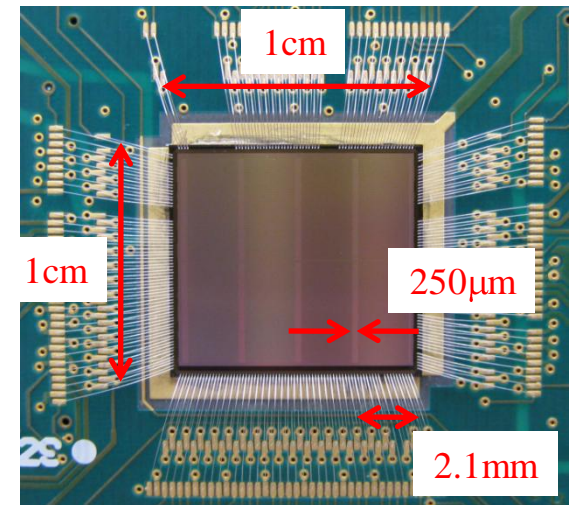

Calibration using ^{55}Fe

- ^{55}Fe gives **5.9keV** photon
 - Deposits all energy in $\sim 1\mu\text{m}^3$ volume in silicon; $1640e^-$
 - If within diode, then all charge registered in single pixel with no diffusion
- Binary readout mean measurement need **threshold scan**
 - Need to differentiate distribution to get signal peak in threshold units (TU)

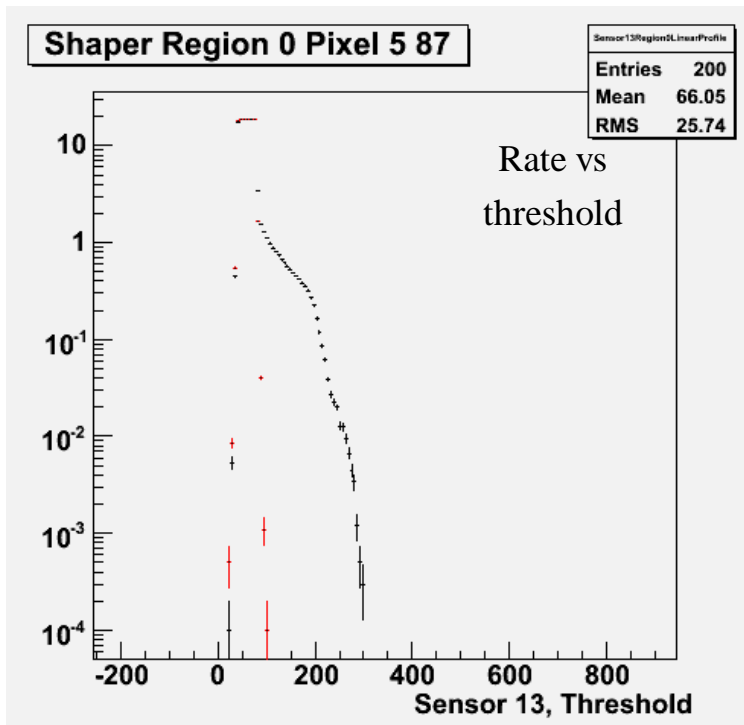

Derivative
approximated
using previous
bin subtraction

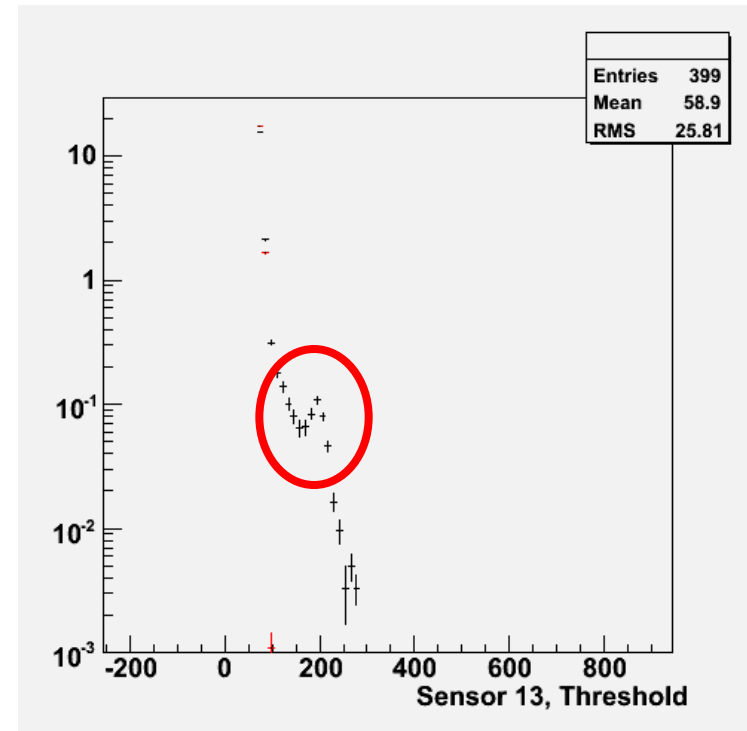

- Signal peak $\sim 200\text{TU}$ above pedestal; $1\text{TU} \sim 8e^- \sim 30e\text{V}$ deposited

Single pixel noise performance

- Also need threshold scan to see **pedestal and noise**
 - Comparator fires on signal going high across threshold level
 - No hits when far above or below threshold
 - Width of distribution equivalent to noise

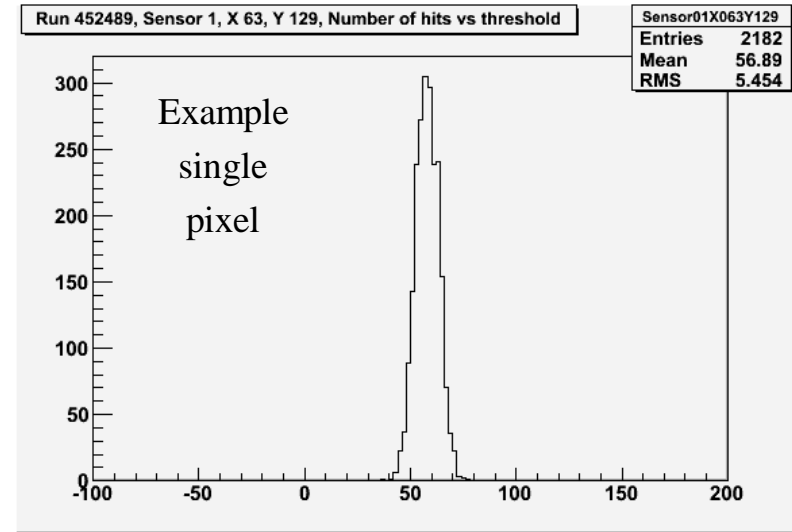

Trim0 Quad0 Sigmas

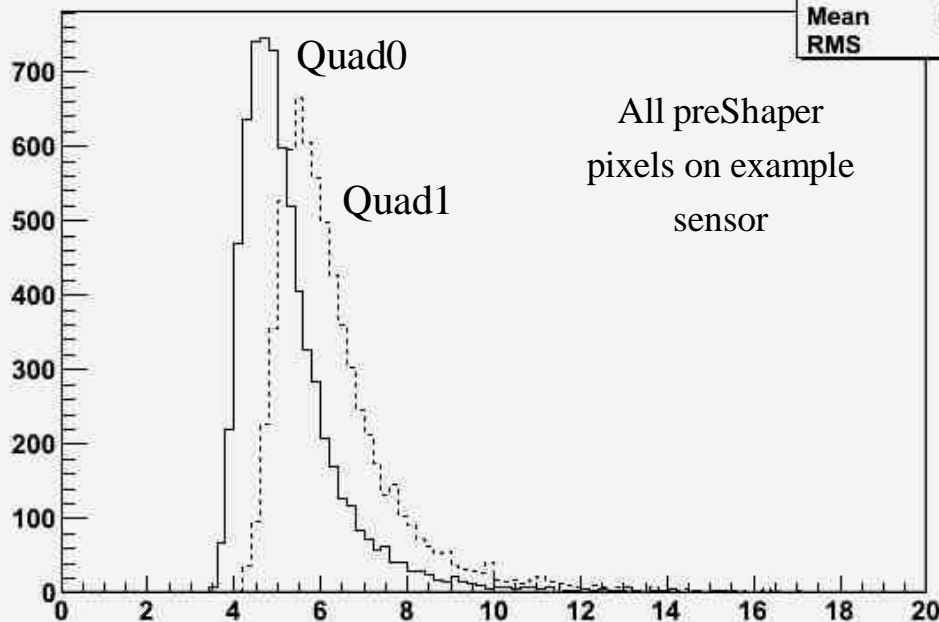

- RMS $\sim 5.5\text{TU} \sim 44e^- \sim 170e\text{V}$ on average
 - Minimum is $\sim 4\text{TU} \sim 32e^- \sim 120e\text{V}$
 - Target level was $\sim 90e\text{V}$
 - No correlation with position on sensor
 - Spread not fully understood
 - Quad1 $\sim 20\%$ larger than Quad0

Single pixel relative gain

Run 470853, X 21, Y 126 vs Threshold (TU)

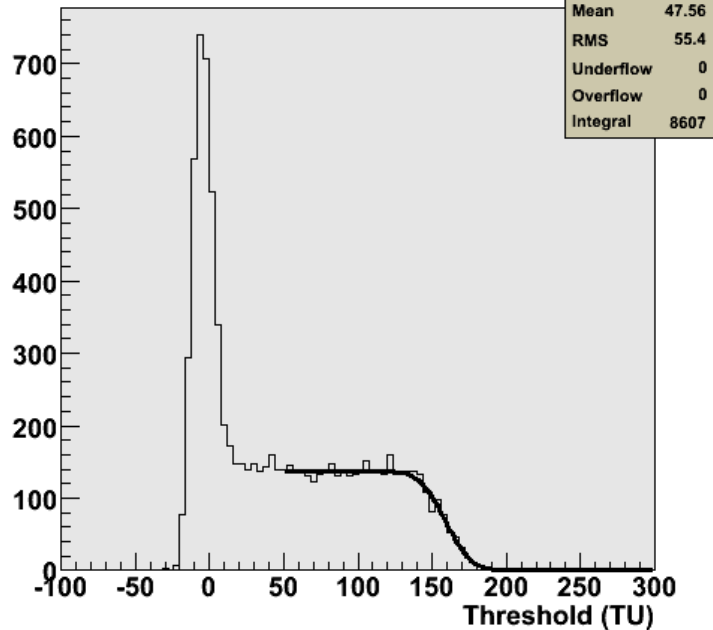

- Measured using **laser**
 - Silicon transparent to **1064nm** light so illuminate from back side of sensor
 - Focus on epitaxial layer
 - Again need to do threshold scan and find edge to measure laser signal

- Fixed laser intensity gives **relative gain** for individual pixels
 - Can do hundreds of pixels automatically
 - Gain uniform to 12%
 - Quad1 ~40% more gain than Quad0
 - Quad1 ~20% better S/N than Quad0

Signal Quad0

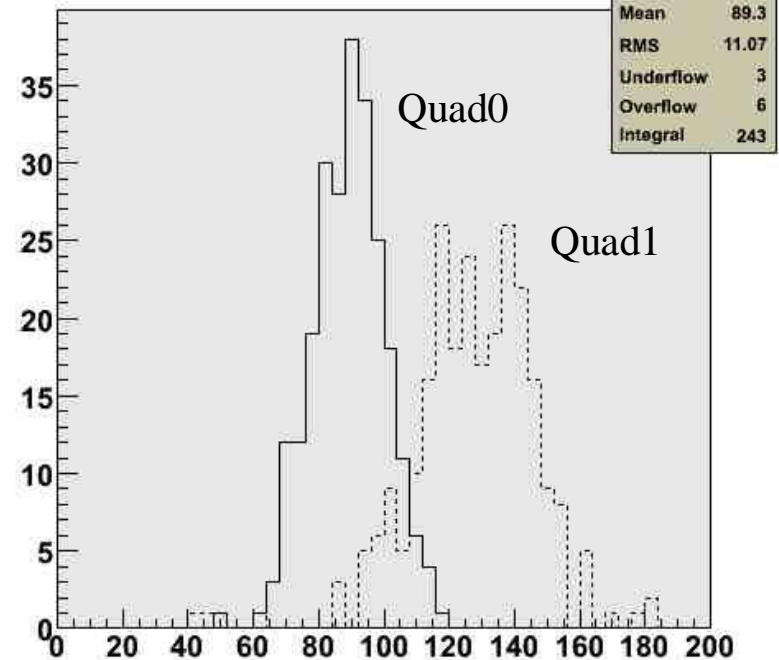

Charge spread

- Charge **diffuses** to neighbouring pixels
 - Reduces signal in “hit” pixel
 - Causes hits in neighbouring pixels
 - Need to make sure this is correctly **modelled**
- Simulation using Sentaurus package
 - Full **3D finite element** model
 - 3×3 pixel array = 150×150μm² area
 - Thickness of silicon to 32μm depth; covers epitaxial layer of 12μm plus some of substrate
- Use laser to fire at **21 points** within pixel
 - Laser spot size < 2μm, step size 1μm
 - Points numbered 0-20, **5μm** apart
 - Symmetry means these cover whole pixel surface
- Measure signal using **threshold scan** in centre pixel and all eight neighbours
 - Numbered “Cell 1” to “Cell 9”

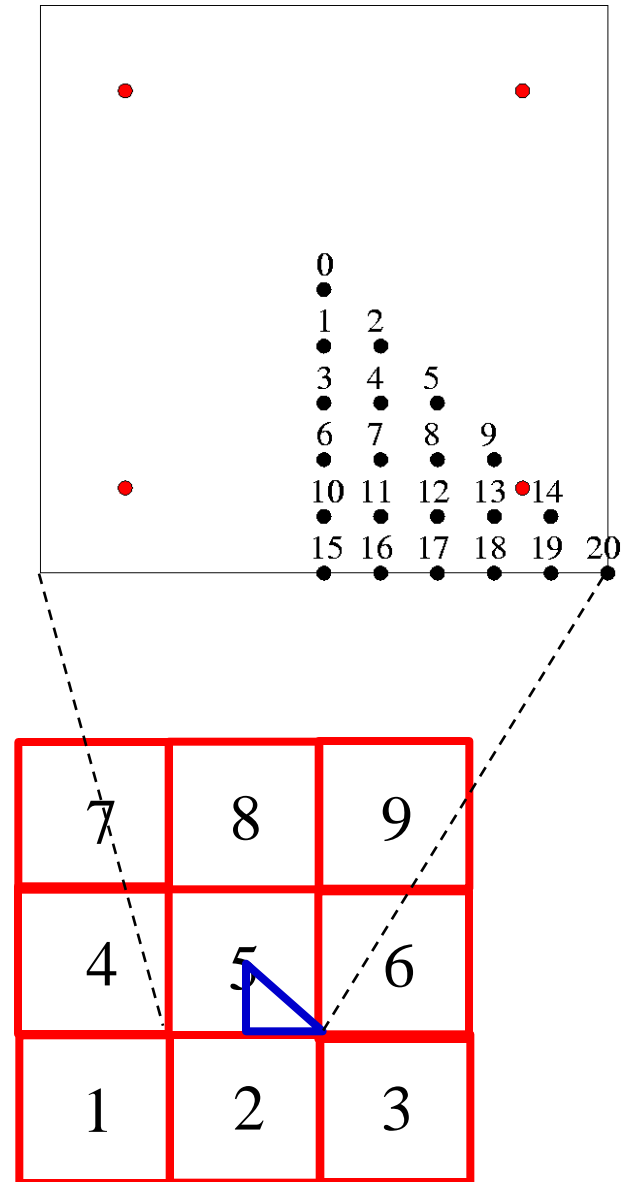

Charge spread results

- Simulation **reasonably** reproduces the spatial dependence
 - Small differences near diodes (points 9,13,14)
- Average signal over whole pixel $\sim 35\%$ of deposited signal
 - Total charge is $1300e^-$ so average $\sim 450e^-$
 - Average signal/noise ~ 10
- **Worst case** signal in central pixel is when hitting corner
 - Gives $\sim 24\%$ of total charge so $\sim 300e^-$ and S/N ~ 7

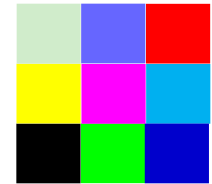
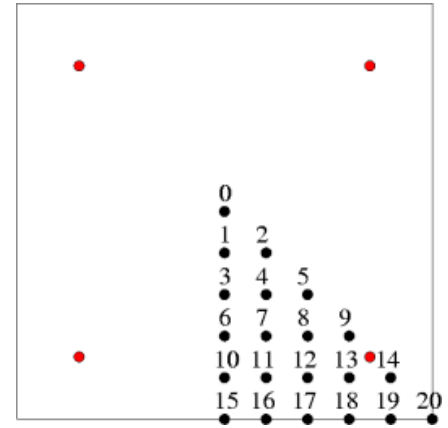

Real data DPW

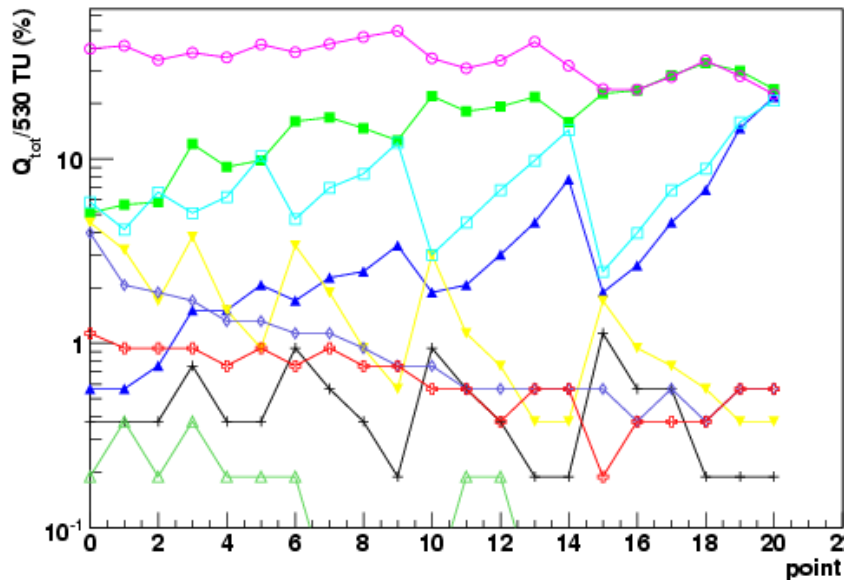

GDS deep p-well

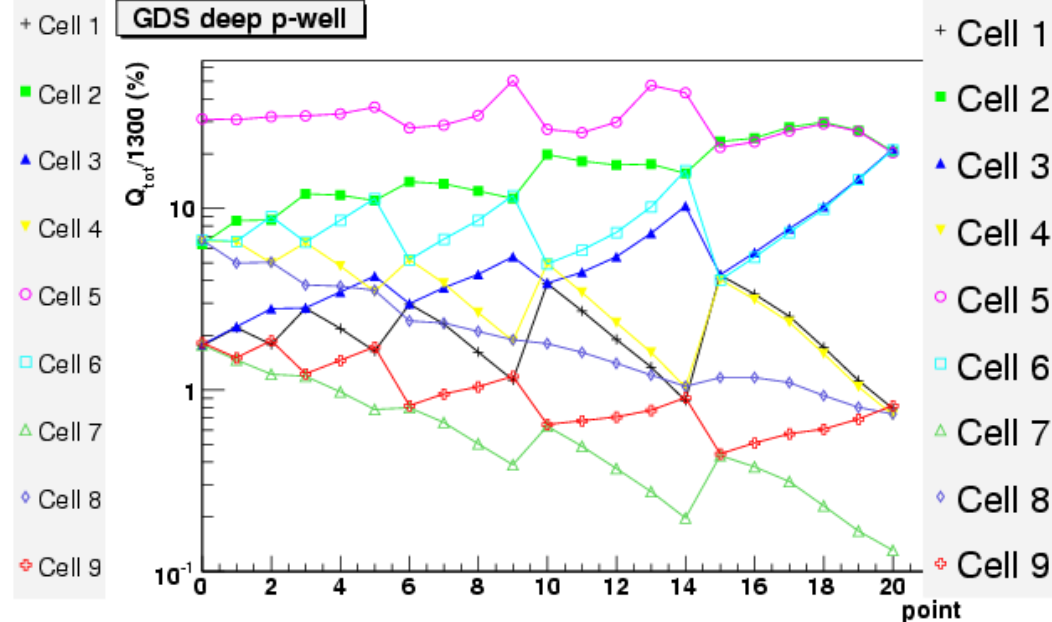

Effect of deep p-well

- Development included **modification** to foundry CMOS process
 - Deep p-well “INMAPS” processing
 - **Blocks** signal charge from being absorbed in pixel amplifier, etc
- Deep p-well **essential** for usable sensor
 - Average signal without deep p-well $\sim 10\% \sim 130e^-$
 - Worst case $\sim 1\% \sim 13e^-$

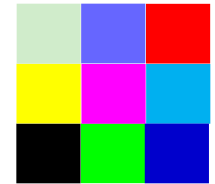
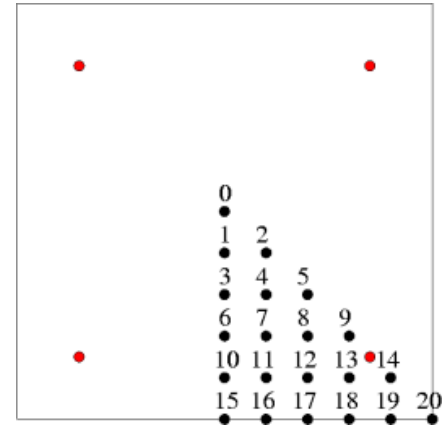

Real data DPW

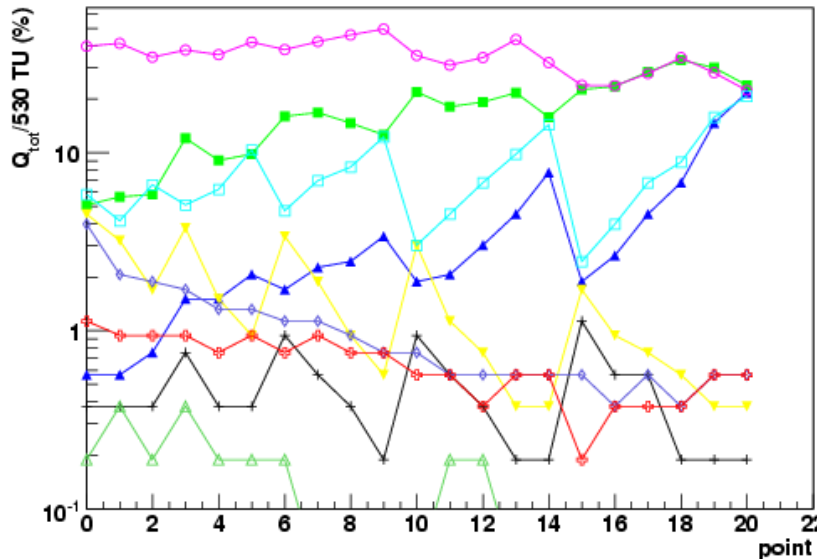

- + Cell 1
- Cell 2
- ▲ Cell 3
- ▼ Cell 4
- Cell 5
- Cell 6
- △ Cell 7
- ◇ Cell 8
- ⊕ Cell 9

Real data NDPW

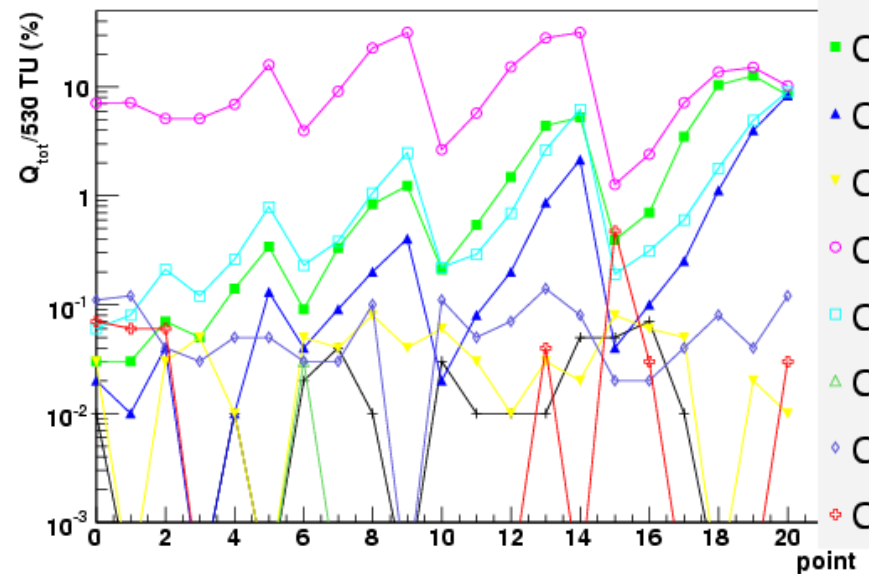

- + Cell 1
- Cell 2
- ▲ Cell 3
- ▼ Cell 4
- Cell 5
- Cell 6
- △ Cell 7
- ◇ Cell 8
- ⊕ Cell 9

Simulation expectation

- Shown at LCWS07 but with no **verification** of assumptions
 - Now have concrete noise values and measured charge diffusion
- Current extrapolation to “real” detector shows **significant degradation** of ideal DECAL resolution
 - 35% increase in error
 - Number of pixels hit not trivially related to number of charged tracks
- Degradation arises from
 - Noise hits
 - Dead area
 - Particles sharing pixels
 - Particles crossing pixels boundaries
 - Charge diffusion to neighbouring pixels
- Importance of various effects **differs**

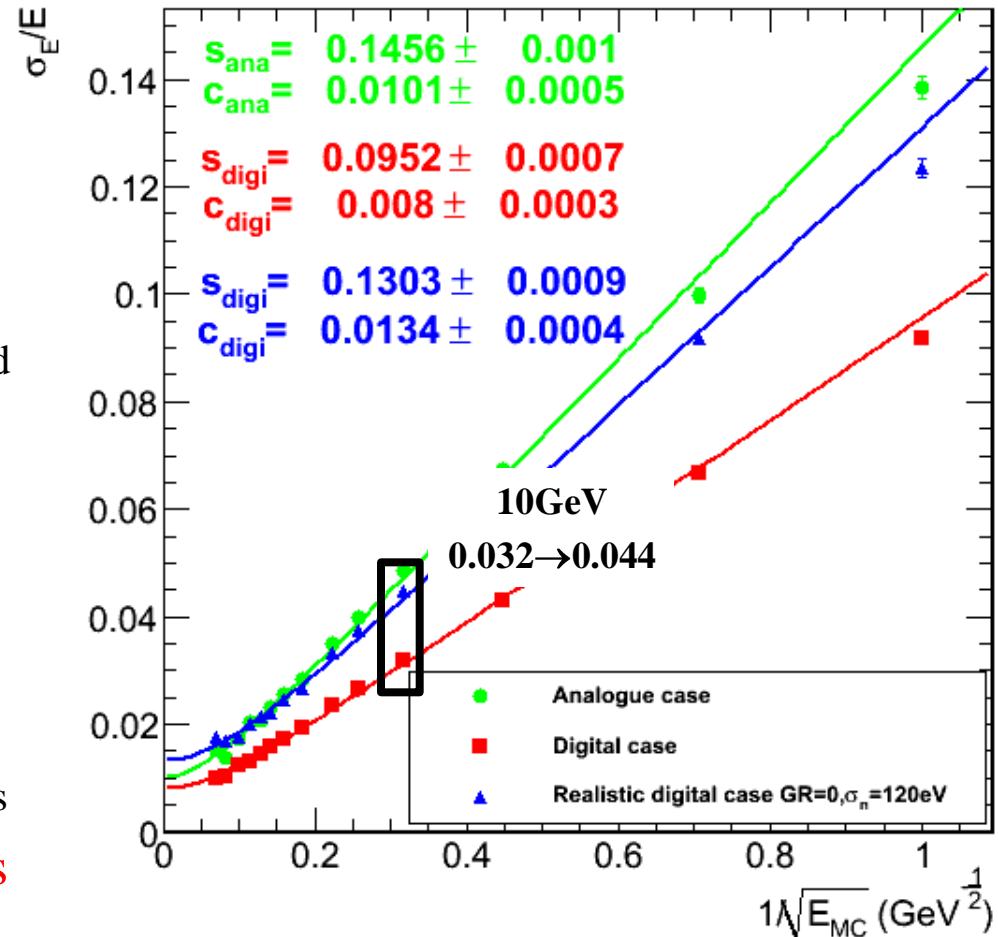

Effect of noise

- Noise adds hits to showers so increases \sqrt{N}
 - Depends very strongly on threshold
- Need to increase **threshold** above noise “wall”
 - Noise has **no effect** for higher thresholds
 - Gain spread $\sim 12\%$ is equivalent to threshold spread here so small effect
- Resolution degradation $\sim 10\%$
 - If S/N can be improved, then get a **plateau** so noise has no effect on resolution

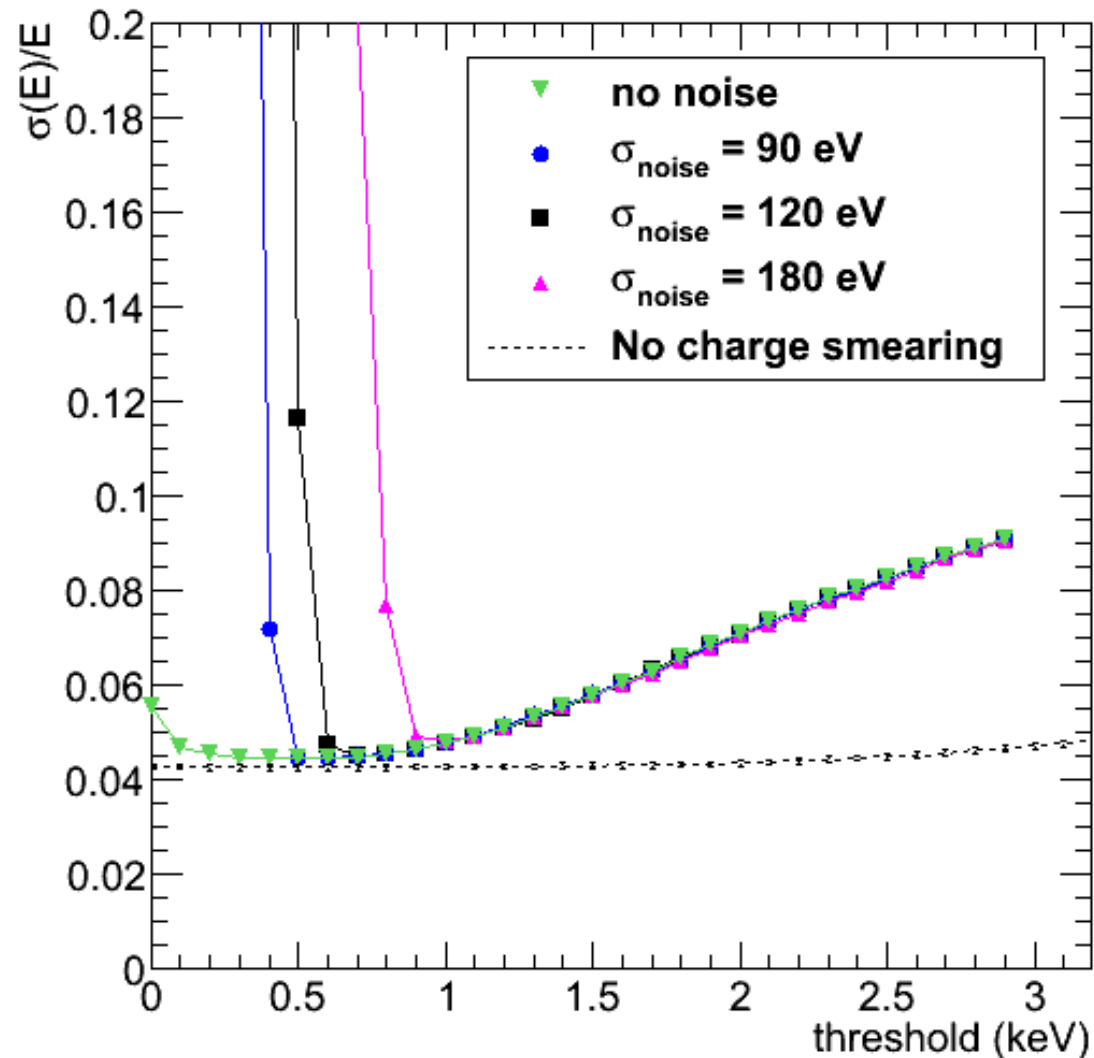

Effect of dead area

- Sensor has **11% dead region** due to on-pixel memory
 - Bands of 250 μ m wide spaced every 2.4mm
- Shower width \sim **1cm** so every shower sees several dead bands
 - Always loses 11% of hits with small fluctuations
- Since $\sigma_E/E \propto 1/\sqrt{N}$, impact is not large
 - Gives $1/\sqrt{0.89} \sim 1.06$ effect
 - Hence \sim **5%** degradation
- Assumes sensor large enough that **edge effects** are negligible
 - May add \sim 5% more dead area in reality so \sim **2%** more to resolution

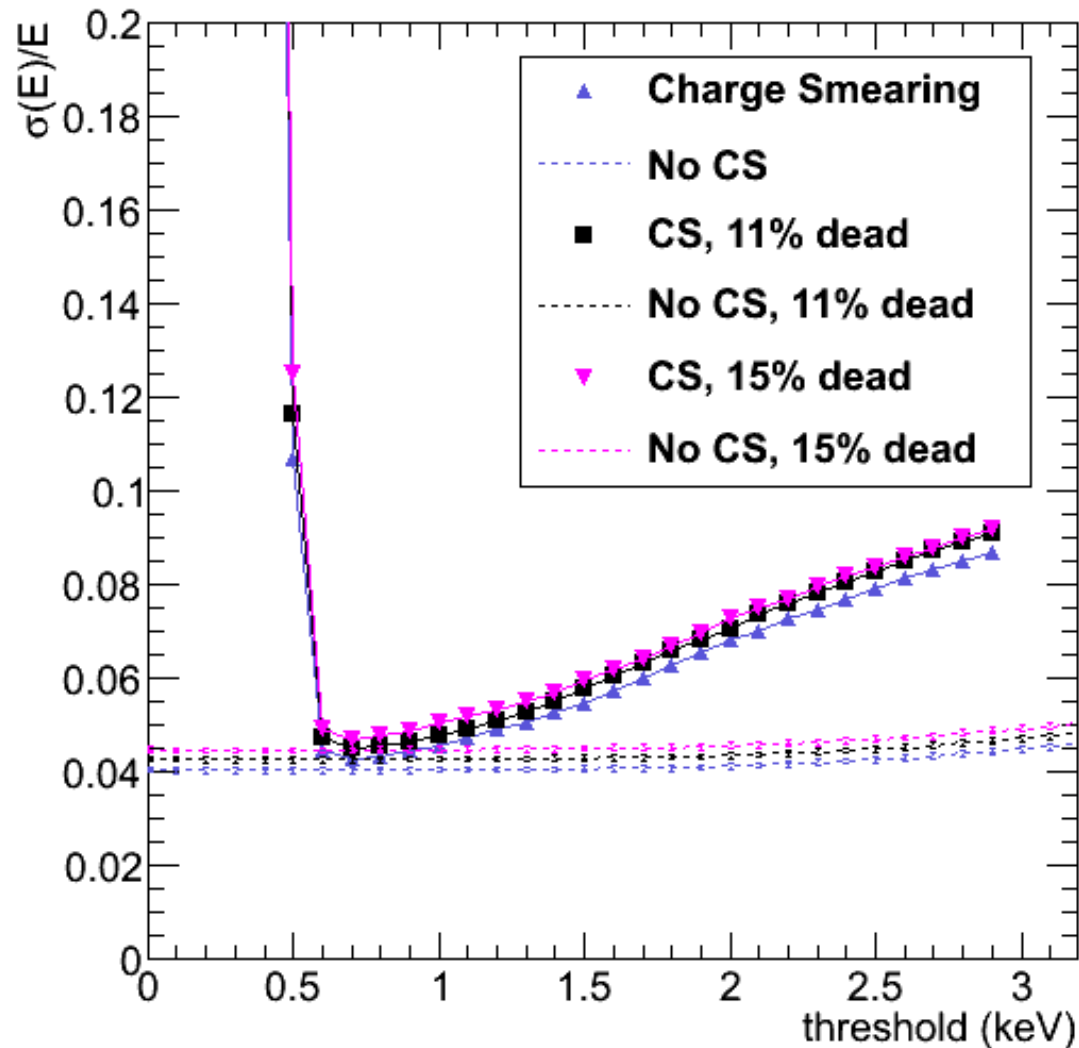

Effect of hit confusion per particle

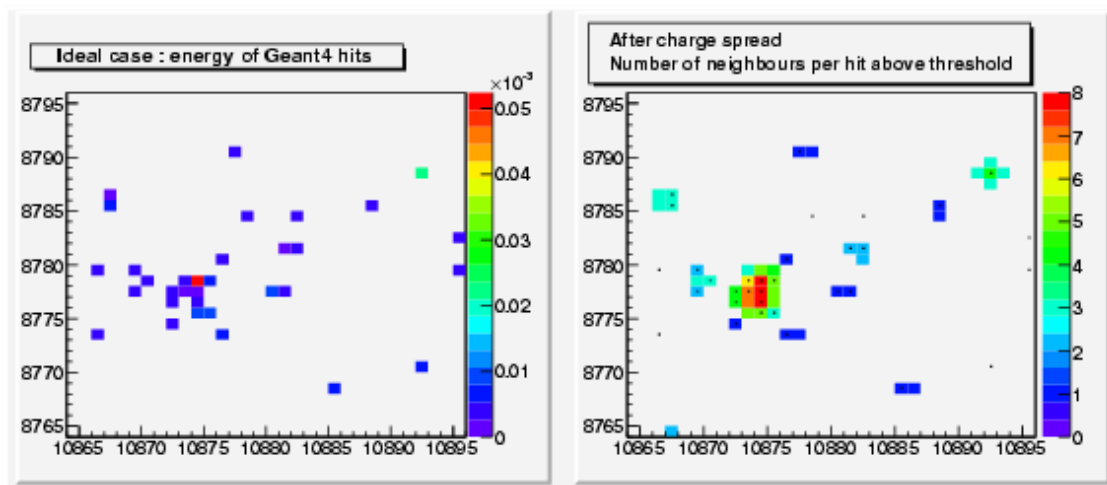

- Need to do neighbouring hit “clustering” to convert hits to particle count
 - Algorithm to use depends on effects which may not be modelled well
- Major study of clustering algorithms still to be done
 - Currently gives ~ 20% degradation to resolution so dominates
 - Essential to get experimental data on fine structure of showers to know realistic resolution

- Arises from
 - Particles close together
 - Particles crossing pixel boundaries
 - Charge diffusion
- Only the last is known to be well modelled

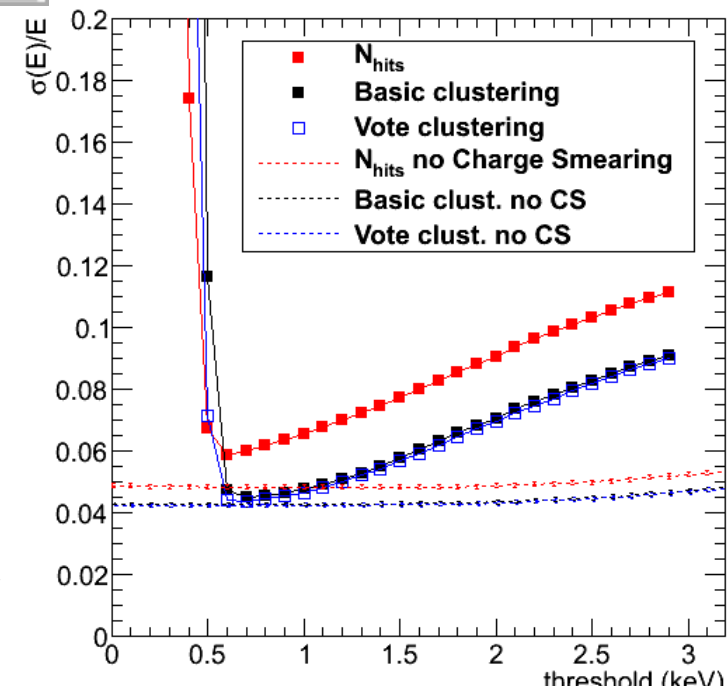

Short term future plans

- “Debugged” version, **TPAC1.1** due back on Sept 23
 - All pixels uniform; **Quad1 preShaper** variant
 - Decoupled power mesh, thought to cause pickup between pixels (and disrupted beam data)
 - Adjusted pixel circuit layout to improve gain and S/N
 - Trim setting has six not four bits to allow finer trim adjustment
 - Other small fixes, e.g. fix low level of memory corruption <1%
- **Pin-compatible** with existing PCB
 - Can **reuse** all readout hardware and firmware
 - Very minor changes to software; only for six trim bits
- Will checked sensor performance fully over **next year**
 - Including **beam test at DESY early in 2009**
 - Dec 2007 beam test data unusable as bad pedestal trimming (due to pickup)
- Beam test will have at most **four layers**, each with a single sensor
 - Data in usual CALICE raw data format although LCIO conversion would need work
 - Will see **real data samples** of showers at various depths in tungsten
 - Compare with simulation at 50 μ m granularity
 - Check critical issues of **charged particle separation** and **keV photon flux**
 - But will probably not verify true performance as a DECAL...

Long term future plans

- Submitting a proposal this week for **large sensor TPAC2**
 - **450×450** pixels and $2.5\times 2.5\text{cm}^2$; a factor ten in area; otherwise a scaled-up TPAC1
 - Bid includes funding for **16-layer** Si-W DECAL stack; 5×5 sensors = $12.5\times 12.5\text{cm}^2$ per layer
 - Smaller than AECAL but OK for basic proof-of-principle
- To pack sensors in the plane, will **wirebond** through slots in PCB
 - Aim for pixel-pixel gap between sensors to be only $500\mu\text{m}$ ~ 4% extra dead area
 - “Real” detector would **bump-bond** but we need to minimise engineering effort for this programme
- A rough **schedule**
 - Sensor design in **2009**
 - Stack assembly and system tests in **2010**
 - Beam test of stack in **2011**
- BUT... **not cheap**, UK funding still very difficult
 - External collaborators **very much welcome**
 - Would very significantly increase probability of approval if cost split with non-UK groups

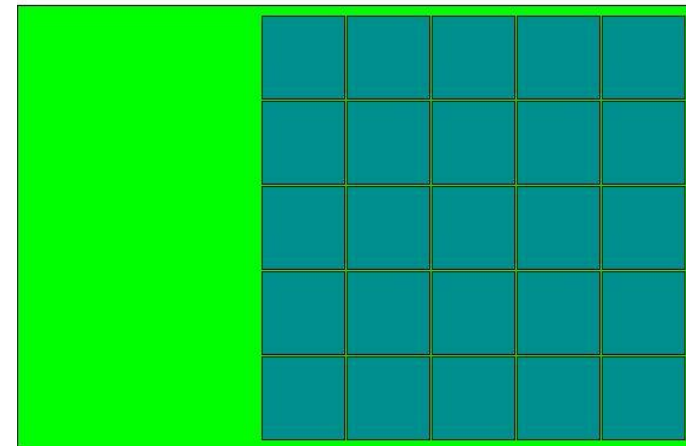
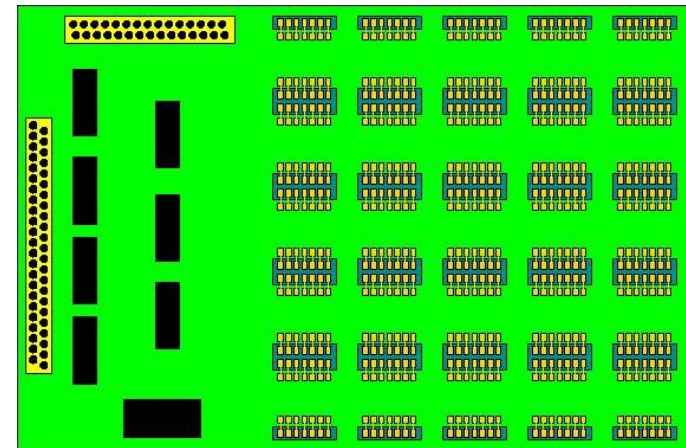

Conclusions

- **DECAL** seems possible in principle
- Actual **EM resolution** which would be obtained depends heavily on details of showers and on algorithm for clustering
- The **simulation** has not been verified at small granularities
- Essential to get **real data** to compare
- Will have first look at **showers** early in 2009
- May have first look at **EM resolution** in 2011
- Approval very uncertain; **collaborators very welcome!**

Backup: Single pixel pedestals

- Pedestal given by mean of threshold scan
 - Pedestal spread is ~ 4 times noise

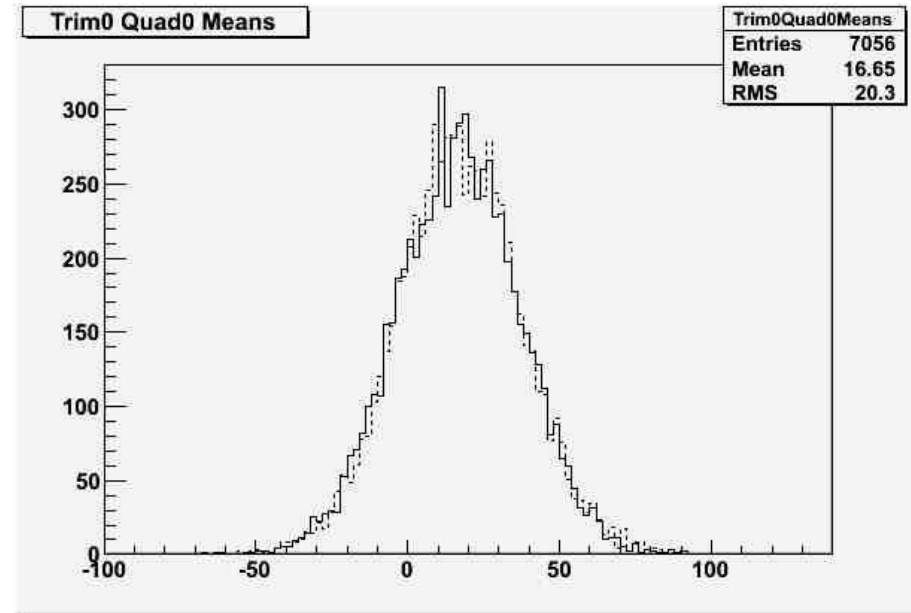
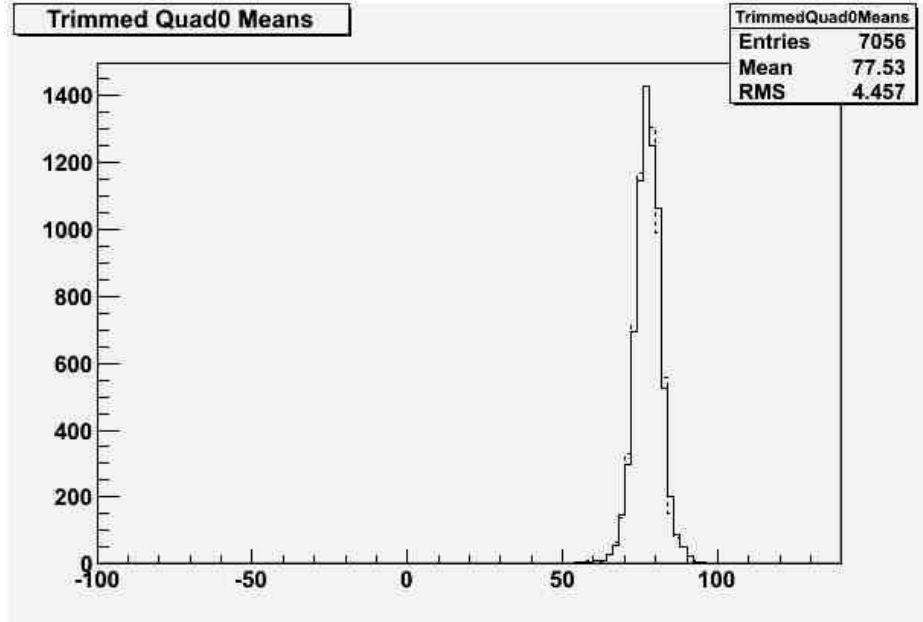

- Must correct using trims to get sensible data
 - Trimming works reasonably well; down to RMS of ~ 4.5 TU
 - Still not completely below noise level so more trim bits would help

Backup: Pedestal and noise over sensor

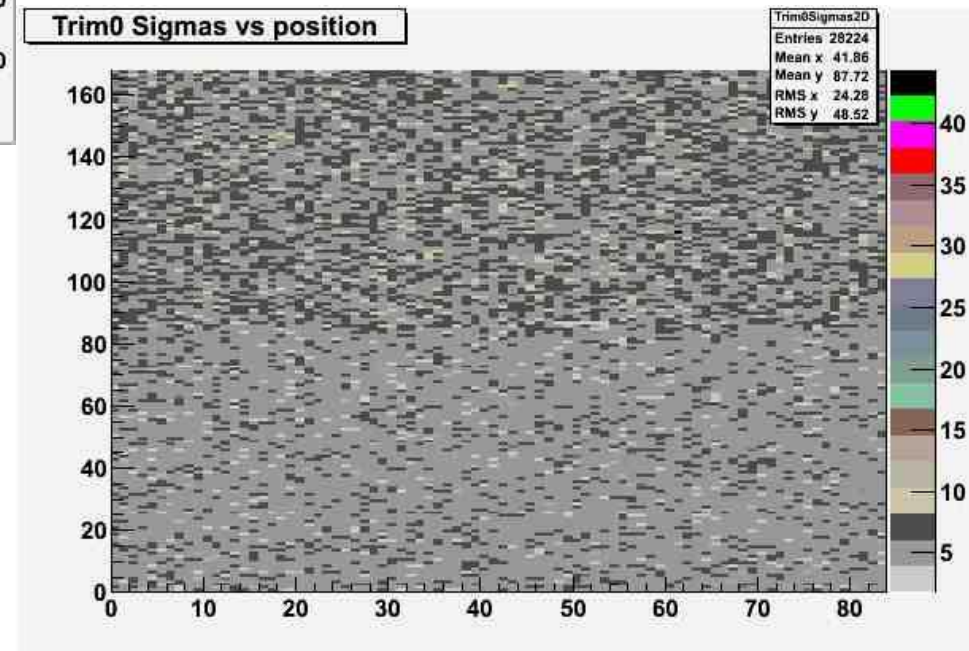
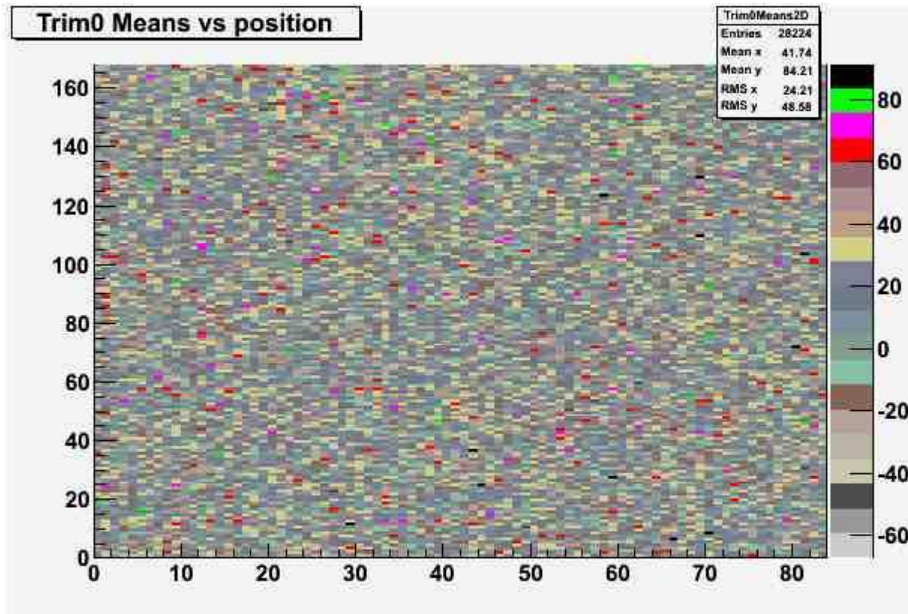

Backup: pixel hit pickup

- Find different results for pixel if other pixels enabled

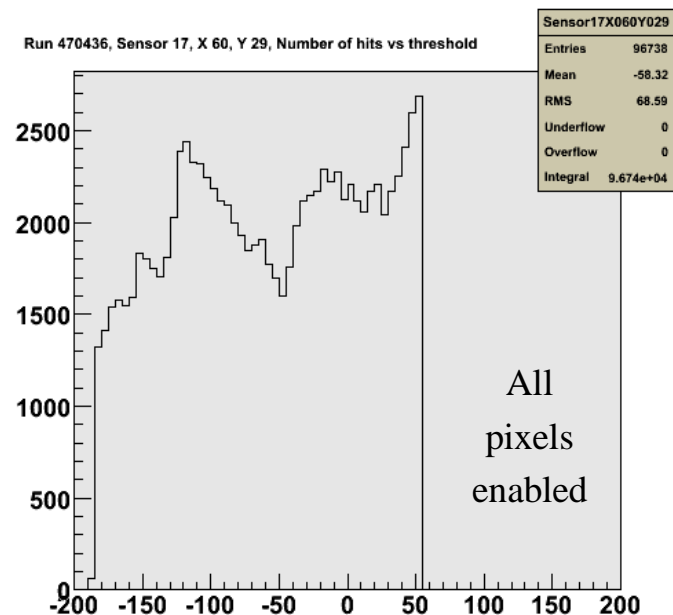
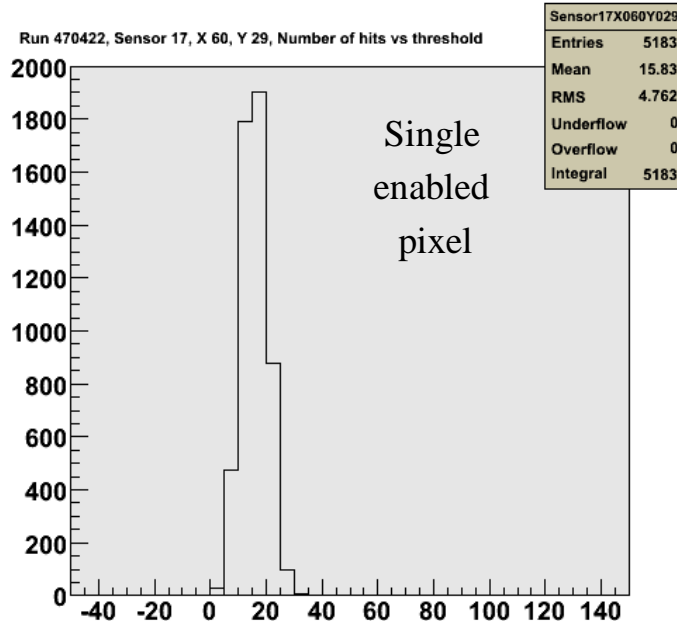

- Prevented pedestals from being determined until effect understood
 - Plots shown previously had most pixel masked
 - Not found before Dec 2007 beam test so data had bad trims; probably unusable
- Probably due to shared power mesh for comparators and monostables
 - If $> \sim 100$ pixels fire comparators at same time, power droops and fires other monostables
 - Not an major issue for normal use (once understood)

Backup: DECAL 16-layer stack

- Should give definitive answer to whether DECAL concept is viable
- 16 layers gives degraded resolution by factor ~ 2
- Funding not available for more layers
- Hopefully extrapolate to realistic calorimeter sampling using simulation

